

# Heaton

1993





## To Our Valued Customers

I would like to thank you for taking the time to view our 1993 line up of custom made goalie equipment. This year's products continue to display the latest in assembly technique, design and materials.

Throughout each year, both myself and my staff continue to pay close attention to trends and comments from all levels of the sport. Ideas filter into us from pee wee players all the way up to direct consultation with players in the NHL. **The goalie who is experiencing the shots is the one who can best tell us what direction we should be heading when doing our product development.**

An ideal situation would allow me to custom fit each player that wished to use Heaton equipment. This is obviously impossible and therefore we rely on the expertise of our dealer network to be the liaison between myself and the end user. Our retailers are carefully selected from the many applications received from shops that wish to become dealers. Those chosen are selected for their knowledge of the position and their conviction that Heaton Custom Goalie Equipment can best serve their customers.

Each year we look to the NHL for the ultimate in acceptance. By providing equipment at this level we can best determine what protection is best suited for all levels of the game.

I would like to draw your attention to our new Helite III goal pad. This is the third generation of our concept pad which has continued to evolve primarily due to goalie preference in shape and performance. We are also introducing a new straight cut goalie pant and new blocker. These new products and various refinements to current products reflect our commitment to advancing the state of the art of goal equipment design.

In closing, if you have never used Heaton products I encourage you to take a close look. If you are a current wearer of our product, I would like to thank you for your support and encourage you to contact us with your comments.

Brian Heaton

PRESIDENT

## Index

HELITE III PADS  
page 1

PRO 90z PADS  
page 2

HELITE II PADS  
page 3

HELITE III Jr. PADS  
PRO 90z Jr. PADS  
HELITE II Jr. PADS  
page 4

SIZING AND STANDARD  
FEATURES  
page 5

SNIDER GOAL PADS  
page 6

3000 CATCH GLOVES  
page 7

2000 CATCH GLOVES  
page 8

WAVE BLOCKERS  
page 9/10

ARM & BODY PADS  
page 11

PRACTICE SWEATERS  
page 12

GOALIE PANTS  
page 13

SPORTS TOTE BAG  
PRO-GRIP TACKIFIER  
HATS  
GOALIE JOCK  
page 14

KLAVA KOLLAR  
THROAT COLLARS  
THIGH PADS  
PROTECTIVE EQUIPMENT  
page 15

CUSTOM COLOR CHARTS  
page 16



## GOAL PADS



*New for 1993, the Helite III is our state of the art product - it represents the latest in the continuing evolution of lightweight, high tech goal pad design.*



The Helite III is available with a "Double Oleg" graphic pattern. This pyramid design generates dramatic optical impact to incoming aggressors.



In response to direct feedback from NHL goalies and other pro players around the world, the Helite III is the result of a unique blend of ideas. The full clarino front and large billowed rolls allow for a traditional appearance and greater puck absorption. In order to maintain light weight, new materials are used internally as well as a new process of pad stuffing. A wrap-around knee flap element (used in the original Helite I product) has been integrated into this new pad to maximize flexibility in the knee area without sacrificing protection.

### **Additional Features**

- Re-designed knee cradle using cream nash material provides an alternative fit to our traditional beaded knee cradle.
- Squared-up design maximizes blocking surface
- New medial roll design minimizes vulnerable open area which may develop below lower roll.
- Sixth roll acts as a barrier against puck penetration as heels are drawn together (and front edge of pads are not).
- Glazed felt backing offers alternative to nylon backing and provide that traditional feel.
- All leather straps for the traditional look.
- Choice of toe straps, toe bridge or "puckfoil" toe arrangement.
- Available in NHL home or away, team black, and Custom Colours - standard or custom made for sizing.

## GOAL PADS

*The Heaton Pro 90 Z relates closely with the traditional goal pad but relies on new technology and synthetics for weight reduction.*



Traditional billowed knee rolls are filled with new Poly Air Fibre which offers flexibility and excellent shock absorption. The mini-rolls which fit between the three larger rolls offer an attractive graphic element as well as

additional protection against puck penetration. This pad tends to appeal to more butterfly style goalies who require the ultimate in flexibility that results from conventional construction.

### **Additional Features:**

- In addition to large vertical rolls, an extended medial roll on the inside provides additional blocking on extended leg saves.
- Choice of leather or nylon strapping and puckfoil, toe straps or toe bridge arrangements to accommodate all possible preferences.
- 400 DENIER nylon backing reduces weight and is non absorbant; knee cradle reduces sway and centers pad on the leg.
- Full Clarino front duplicates look and function of leather but is more durable and does not take up water.
- Extra large wing wraps and knee flares with plastic caps provide protection from side shots.
- Available in NHL home or away or CUSTOM COLOURS standard or custom made for sizing.

All Heaton goal pads can be ordered with toe buckles, toe bridge with lace or "Puckfoils". Check with your league for rule restrictions on toe arrangements.



# HELITE II

## GOAL PADS

Heaton

*Our best selling pad - the Helite II is a second generation product that merges the technology of air cell management and traditional deer hair construction.*



The HELITE II goal pad can also be ordered in the "Oleg" graphic pattern. A pyramid design to generate optical impact.

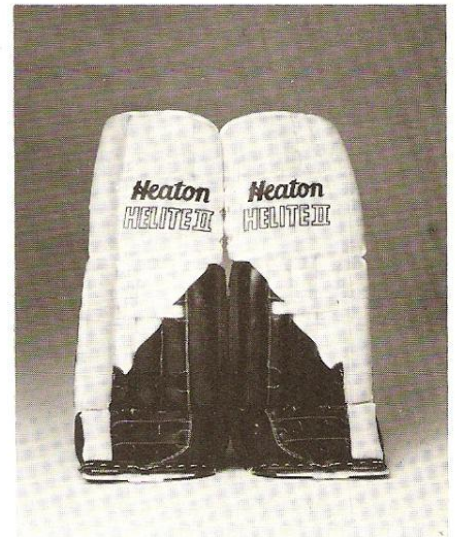

This combination creates a product that is light in weight but provides protection required at the NHL level. The outer surface of the shin and knee rolls are Clarino leather, while the rest of the pad is covered in strong Cordura nylon. The Clarino front has stretch, slide, and rebound characteristics similar to natural leather but unlike leather does not absorb moisture. The Cordura nylon is also a durable light weight material that does not absorb moisture.

### Additional Features

- Beaded knee cradle reduces lateral sway and helps to center pad on player's leg.
- Heaton design patented "PUCKFOIL" provides additional blocking surface below pads.
- 400 DENIER NYLON used on back of pad reduces weight and eliminates water intake.
- Quick release buckle arrangement allows infinite adjustment of leg straps.
- Available in NHL home or away, and CUSTOM COLOURS - standard or custom made for sizing.

# JUNIOR HELITE III

## GOAL PADS

*Designed with the form and function of the Pro model, THE NEW Junior Helite III will appeal to the serious up and coming goaltender.*

### Additional Features:

- Billowed knee and vertical rolls reduce rebounds.
- Glazed felt backing for that senior pad look and feel.
- Constructed of non-absorbant materials so light weight is maintained.
- Quick release buckles and nylon straps make for easy on-off operation.
- Available in NHL home or away, team black and Custom Colours 27" 29" or 31" sizing.



# Pro 90z Jr.

## GOAL PADS

*Very similar in design to its senior counterpart, the Jr. Pro 90 Z suits the player who prefers the look and feel of conventional style pads.*

### Additional Features:

- Traditional knee rolls and natural stuffing provide maximum flexibility for butterfly style players.
- Choice of leather or nylon strapping and is available with puckfoils or toe buckles.
- Nylon backing helps maintain light weight - yet is non-absorbant.
- Full Clarino front duplicates look and function of leather.
- Available in NHL home or away or CUSTOM COLOURS 27", 29" or 31" sizing.



# JUNIOR HELITE II

## GOAL PADS

*Patterned after the Pro level Helite II, this junior level product has all the looks and protective features of the Pro model.*

### Additional Features:

- Clarino and Cordura materials offer durability and light weight.
- Simulated knee cradle helps to center pad when coming up from a save.
- Nylon backing reduces weight and does not absorb moisture.
- Quick release buckles and nylon straps make for easy on-off operation.
- Available in NHL home or away or CUSTOM COLOURS 27", 29" or 31" sizing.

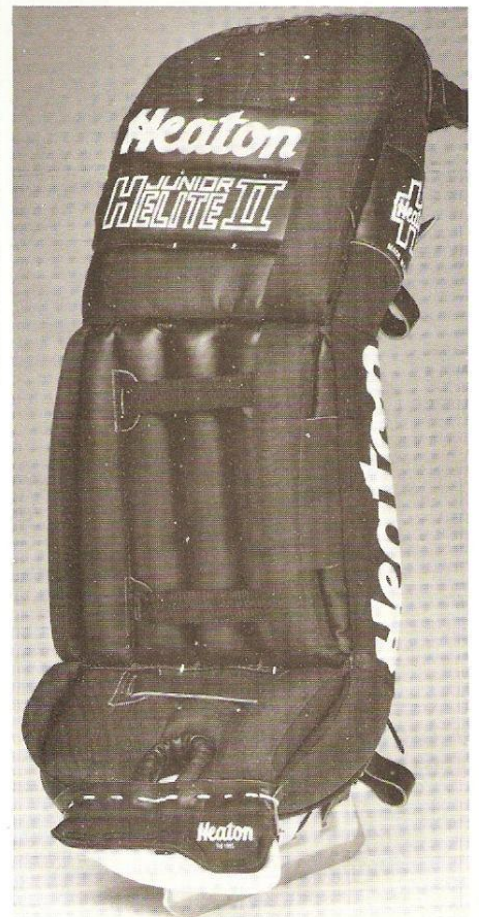

**STANDARD FEATURES AND SIZING**

*Sizing is a critical part of feeling comfortable on the ice. Heaton pads have been developed around a simple sizing procedure.*

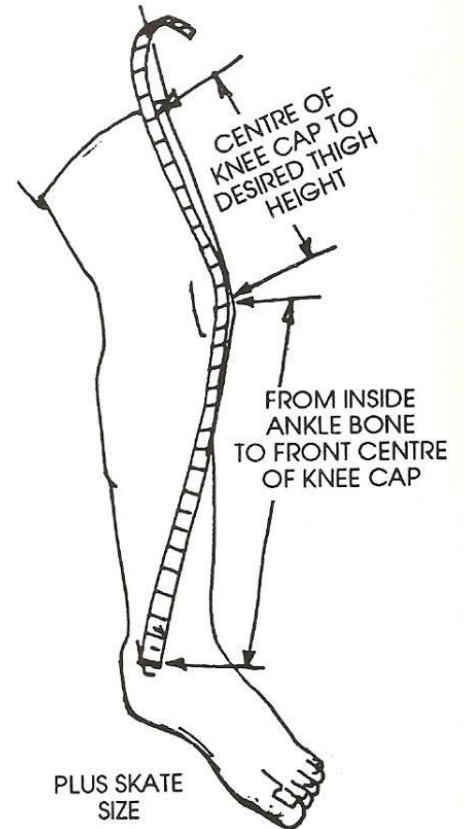
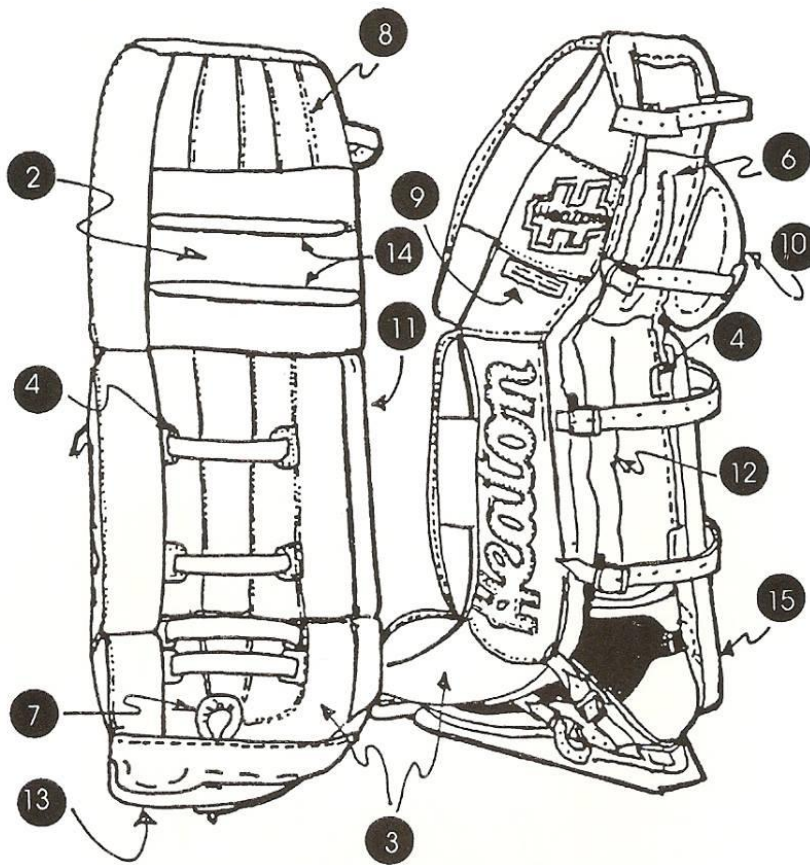

1. All pro pads have deer hair strategically located for maximum protection.
2. Embedded plastic knee caps for shock dissipation.
3. Moisture barriers of coated nylon in toe areas.
4. Reinforced strap slots.
5. Rot resistant twine used to close pads.
6. Leather Knee Cradle to secure pad on knee.
7. Tear-drop toe opening minimize rebound off toe of skate.
8. Double stitching for longer life.
9. "Custom made for" patch to identify owner.
10. Inside knee flare.
11. Medial Roll which broadens front blocking surface without exceeding limits.
12. Lock-stitch on centre channel to assure against unraveling of twine.

**Options:**

13. The Heaton design registered "Puckfoil" prevents the puck from sliding under pads. Provides more blocking surface. Or, one can order toe buckles or toe bridge.
14. Mini Knee Roll Package with sewn logo on gusset.
15. All pads are built with standard wing calf wraps. A full wing wrap can be ordered to cover more of the calf.

1. Measure the distance from the INSIDE ankle bone up to the FRONT centre of the knee cap. This done while the leg is slightly bent.
2. The Thigh Rise of the pad, which is the area above the knee rolls, is determined by measuring from the FRONT centre of the knee cap up to the desired height on the front of the thigh.
3. The third dimension is the size of the goal skate.
4. Provide proper spelling of owner's name for the "Custom Made For" label.
5. Provide model and colour combination. Colours can be illustrated by photocopying the line drawing on the back cover and colouring to your preference.

An example of a common size pad for a 5' 10" adult would be:  
 Ankle to Knee = 17-1/2",  
 Thigh Rise = 7", Skate Size = 9.

## GOAL PADS

The SNIDER line of goal pads "by Heaton" are designed and priced for goalies who require good protection at an affordable cost.



This highly functional product combines the latest in high-tech, lightweight, foam construction with Heaton's state of the art cutting technology. Many features found

only on more expensive leg pads are standard on the SNIDER line.

### **Additional Features:**

- Deep channel construction form fits to player's leg.
- Clarino knee rolls and cordura nylon face offer durable, non-absorbant characteristics and an "expensive pad" look and function.
- Quick release buckles and long wearing nylon strapping provide easy on/off operation.
- Billowed knee rolls direct puck rebounds downward.
- Fifth roll on inside provides extra protection for puck penetration.
- Calf wrap and knee flare protectors add protection against side shots.
- Available in White, Black, Detroit, Toronto, and Montreal colours.  
Available in 25" 27" 29" Junior sizes, and 30", 31", 32" 33" and 34" Senior sizes.



# 3000

# Heaton

## CATCH GLOVES

*Inspired by the style and acceptance of the successful 1850 series Heaton glove, the 3000 has quickly become the best selling glove on the market. New coloured lacing option has been added for 1993.*

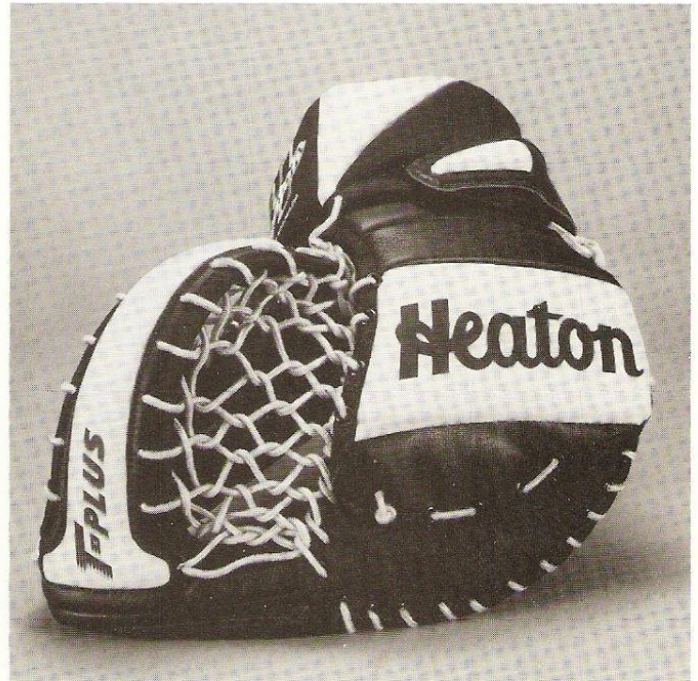
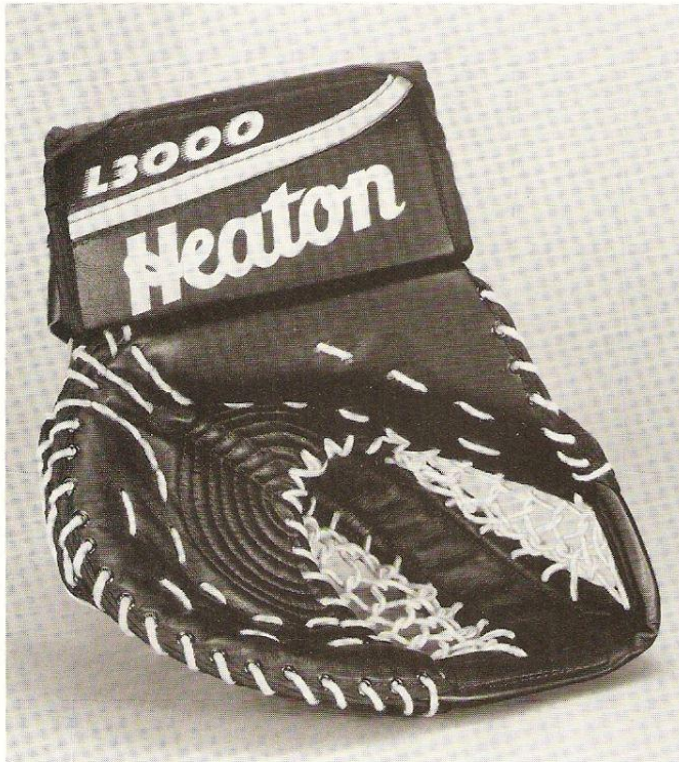

This exciting new product quickly gained the reputation as the "latest" in catch glove design and appearance. It's foam moulded accents and unique flared cuff design will distinguish it and those who use it from everything else on the ice. Junior model also available.

### **Additional Features:**

- 60 degree design for those who prefer a more angular shape for greater range in oversoulder catches.
- "T-Plus" deep pocket for better puck catching and retention.
- Padded inside wrist closure for comfort and positive fit.
- Flared cuff design to direct puck in toward body.
- Terry pad foam insert aids in sweat absorption in senior models.
- Orthopedic leather inside palm on senior models helps prevent rash and irritation and gives that "natural" feel.
- Your choice of grey nash or matching Clarino catch surfaces - Large (L) and Medium (M) palm sizes in pro model.
- Available in NHL home or away, team black or custom colours.

## CATCH GLOVES

*Our best selling 2000 series gloves have been a tremendous success since their introduction in 1990.*



These gloves were developed to capture the growing demand for a glove that required minimum break in time and provide greater stick control.

### **Additional Features:**

- 30 degree design allows maximum catch surface for a "rounder" style glove with integral stick channel.
- "T-Plus" deep pocket for greater puck retention.
- Small, medium and large sizes in senior model to accommodate different size palms (S.M.L).
- Terry pad foam insert aids in sweat absorption on senior models.
- Orthopedic leather inside palm (on pro models) to prevent rash and irritation and give that "natural" feel.
- Your choice of grey nash or matching coloured Clarino catch surface.
- Available in NHL home or away or CUSTOM COLOURS.
- Available in Junior and Novice models which capture the look and feel of their Pro counterparts, (J and JR.).



16" LONG

15" LONG

14" LONG

13" LONG

12" LONG

## BLOCKERS 1575/1675

New for 1993, the 1575 and 1675 blockers are a logical extension of the very successful "Wave" blocker models so popular throughout the sport.

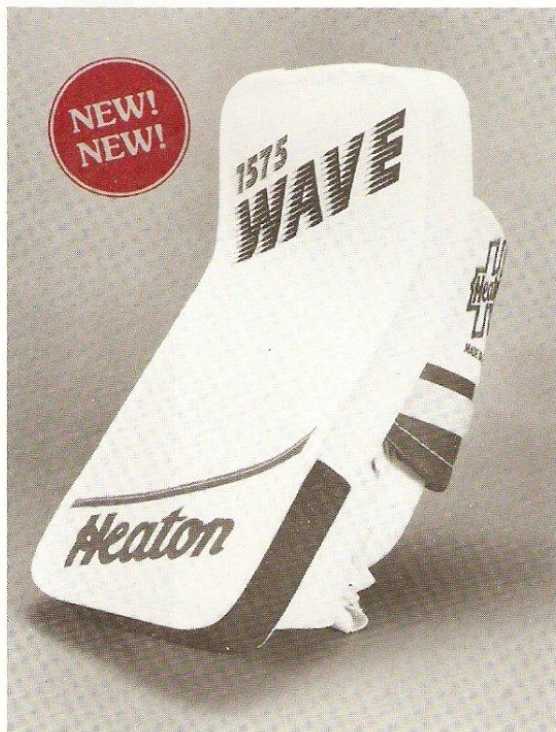
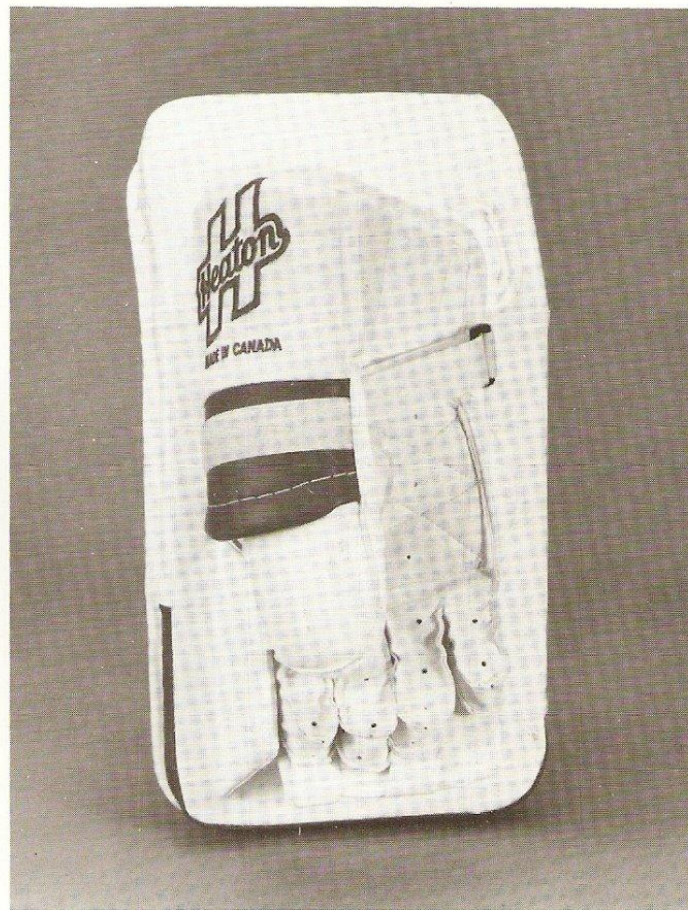
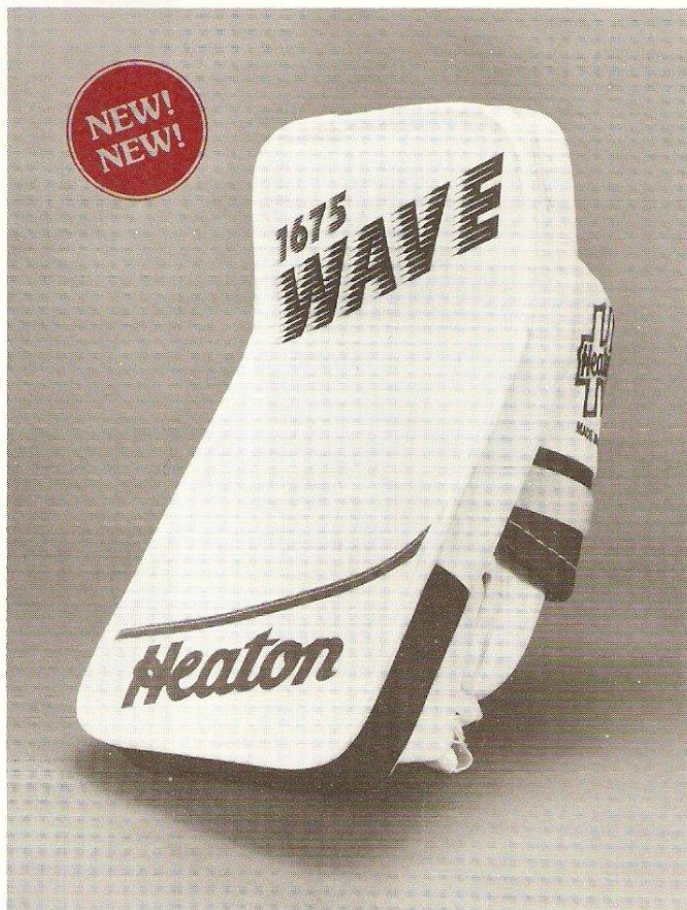

These NEW blocking gloves incorporate all the design features of their predecessors and more! A hinged "armadillo" type thumb has been added to reduce the possibility of hyper extension of the thumb. Also included is greater side protection. A zippered closure offers cleaner design and facilitates quick change of interior foams.

### Additional Features:

- 1 1/2" foam construction has been maintained for maximum protection and durability.
- Full cinch strap on wrist provides greater range of adjustment for a tight fit.
- Shorter cuff lessens interference with arm pad and reduces bulk.
- Available in NHL home or away, team black or Custom Colours.

## BLOCKERS 1375/1475

*The Heaton "Wave" blocker has become a standard in the realm of goaltending equipment.*



This blocking glove was developed to accommodate the wrist action required for shooting the puck. The exaggerated upwardbend in the face begins at the wrist and angles up to provide freedom of movement, and helps to deflect the puck up and over the net as well. Both senior and junior models are offered, (1475 and 1375). Traditional flat blockers (with a slight radius) are offered in a senior model (1400) and Novice version (JR 1300).

### **Additional Features:**

- 1 1/2" foam construction provides maximum protection, firmness and light weight.
- New finger pad extension offers greater protection.
- Available in NHL home or away or CUSTOM COLOURS.



## ARM & BODY PADS

The Heaton arm and body pads are known throughout the sport for their superior protective qualities as well as flexibility and lightness.

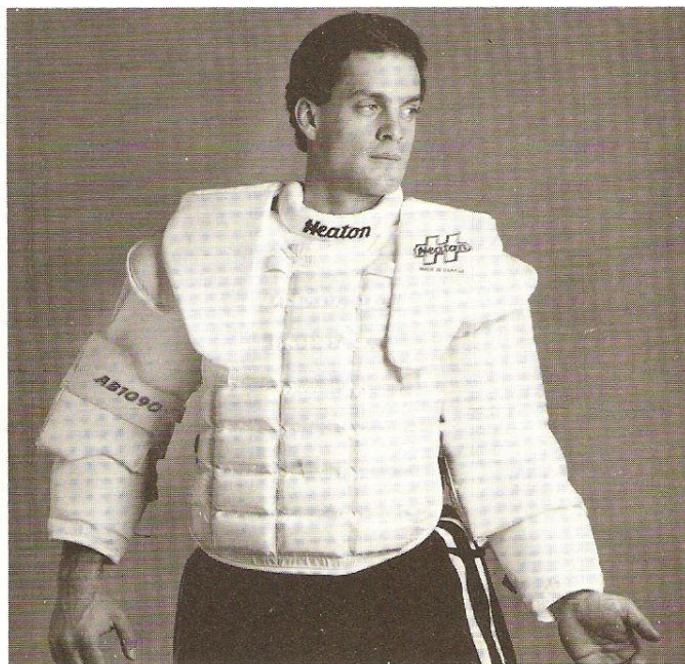
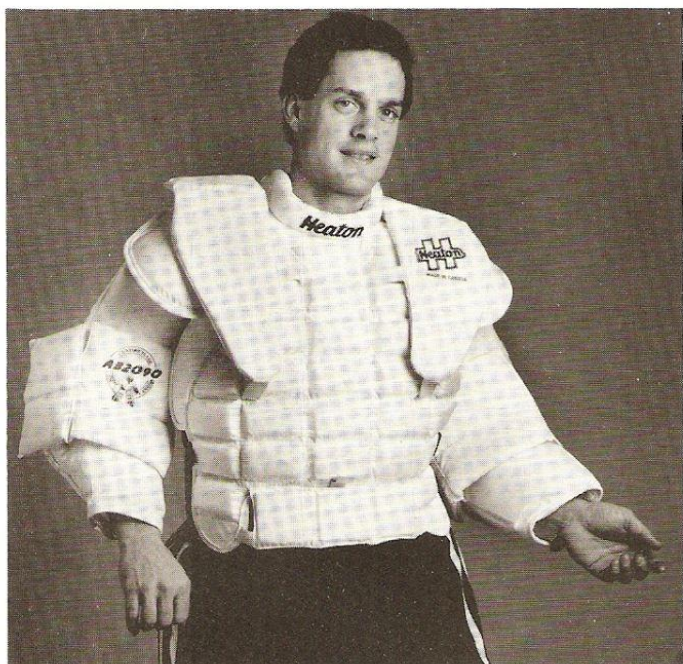

Pro Model (AB2090)



Junior Model (AB990)



Intermediate Model (AB1090)

### Additional Features:

- Expandable waist construction to avoid binding in a crouch-provides additional hip protection as it spreads.
- Multi-layer elbow pad construction assures flexibility and maximum protection at all degrees of arm range-moulded poly caps used in 2090 on elbow and shoulder areas.
- Spinal pad with expandable waist band offers protection in this vulnerable area while minimizing restriction of movement (full kidney pad on 2090 offers complete protection).
- Wing elements on shoulder provide excellent protection that extends up and over top of shoulder when in a crouch.
- Available and sized by height in all models colour options are white, black, blue or red.

### Fitting Guide (By Height)

JUNIOR	M - 4'	to	4' 3"	ADULT	S - 5' 2"	to	5' 5"
	LG - 4' 4"	to	4' 8"		M - 5' 6"	to	5' 9"
	XL - 4' 9"	to	5' 1"		LG - 5' 10"	to	6'
					XL - 6' 1"	to	6' 5"

## PADDED PRACTICE SWEATER

*A most unique product from Heaton that affords greater protection in practice sessions, is our padded sweater.*

High density polyethylene foam inserts give the player that extra measure of protection when worn over top of the arm and body pad.

### **Additional Features:**

- Extra large sleeves allow lots of room for arm movement.
- Bulky mesh material allows for maximum heat dissipation.
- 100% POLYESTER material is comfortable, durable and washable.
- Available in black only - S, M, L and XL sizing.

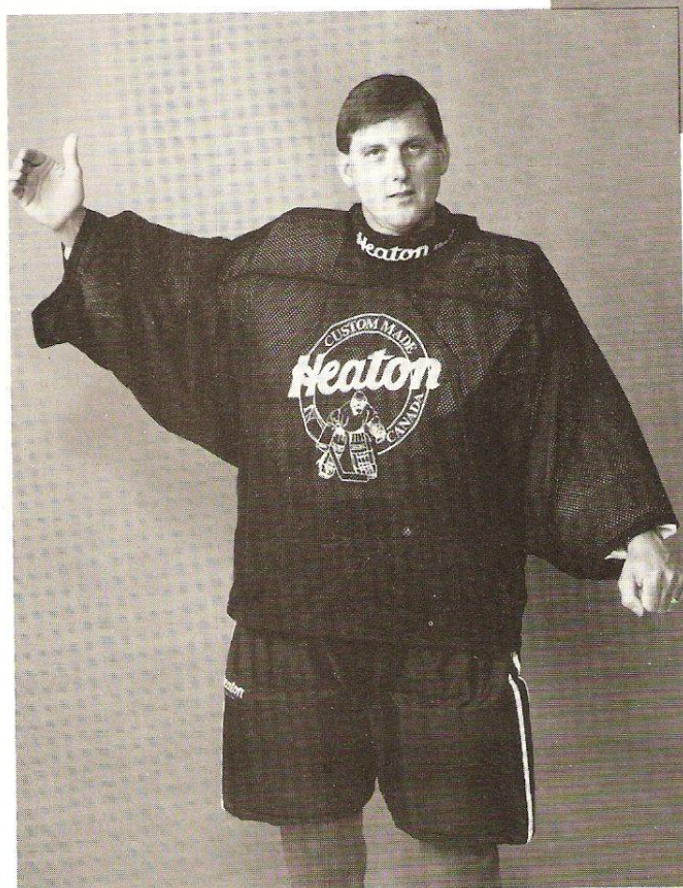
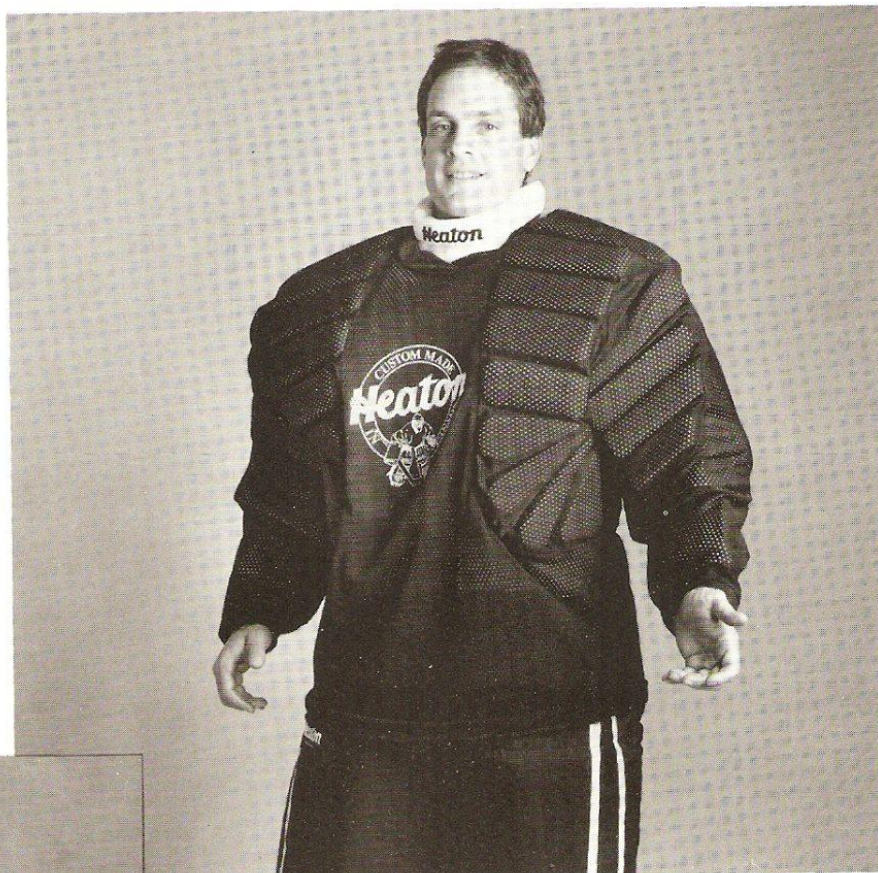

## NON - PADDED PRACTICE JERSEY



This non padded version of the trend setting Heaton practice sweater has universal appeal and is affordable to all levels of players.

### **Additional Features:**

- Extra large sleeves provide lots of room to move.
- Top and bottom cover stitch design adds to durability and long wear.
- Medium, large and extra large sizing available - black only.

## GOALIE PANTS

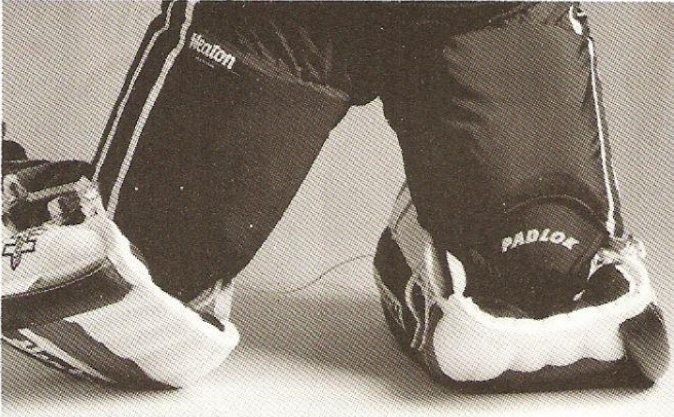

Compression molded plastic parts add strength, durability and increased protection particularly in the "5 hole" area.

### Additional Features:

- European taper design for custom fit
- Wrap around protection in lower spinal and inner thigh area for increased protection.
- Rib Knit material in crotch and leg areas expands to offer complete freedom of movement.
- Can be worn with belt (included) or suspenders.
- Inside liner complete with pelvic protector for added comfort and safety.
- Available in senior and youth sizes form 22/24 to 50/52 (normal fit is one size up from waist size).
- Available in black, blue, red, green; striped with corresponding colour/white stripe or plain.
- Regular or tall lengths available.

The Pad-Lok goalie pant with built-in thigh guard further confirms the reputation Heaton has established for innovative design in protective gear.



Designed to protect the player's lower thigh (especially in a down position) the thigh protector is elasticized so as not to restrict movement.



The new STRAIGHT CUT PANT offers a loose fitting alternative to those goalies who prefer a non tapered pant.

## STRAIGHT CUT GOALIE PANTS



### Additional Features:

- Padded belt for extra protection.
- Scalloped waist band reduces frontal interference with body pad.
- Broad thigh coverage maximizes overall blocking surface.
- Compression moulded plastic parts add strength and durability and provide excellent protection.
- Super soft inside liner with pelvic protector offers ultimate in comfort and excellent down under area protection.
- Pull tabs for easy on-off handling.
- Available in senior and youth sizes from 22/24 to 50/52 (normal fit is one size up from waist size).
- Available in black, blue, red, green; striped with corresponding colour, white stripe or plain.

## SPORT TOTE BAG



The new sport tote bag is graphically similar to the popular equipment bag which inspired its creation - and just as durable!

### Additional Features

- 420 denier vinyl backed nylon for long life and heavy duty use.
- Double top zipper allows ease of operation and high access to large main compartment.
- Isolated, zippered end compartments allow independent access and segregation of articles.
- Non-absorbant materials are totally unaffected by moisture.
- Shoulder strap/grab handle combination offers convenient and comfortable carrying.
- Velcro side pocket provides quick access to items without use of zippered compartment.
- Available in black/black, black/red, black/blue or black/green colour combinations.

## PRO - GRIP TACKIFIER



This revolutionary resin creates a tacky surface for better grip but does not leave a residue on the skin - may become to hockey equipment what pine tar is to baseball.

### Additional Features:

- Water based as opposed to solvent based - reducing the chance of skin irritation.
- Self-storing applicator is easy to use and clean storing.
- Available in easy to handle, non-breakable plastic bottles.
- Handy 12 pack merchandiser.

## HATS



Heaton has teamed up with New Era® (the # 1 name in caps) to produce the best quality hat on the market. This is the same cap worn by the Pro baseball players and is now available with the Heaton logo!

### Additional Features:

- Premium quality 14 oz. wool pro ball club pattern.
- Swiss embroidered for that classic look.
- Top stitched, 5-ply sweatband with no-roll design.
- Visor is .09 inches thick so it not only retains its shape but is unbreakable.
- Available in medium and large sizes and assorted colours.

## GOALIE JOCK



The Heaton goalie jock with banana style cup offers the player maximum frontal as well as down under protection. Available in both senior and youth models, the overall design of the product combines superior protection with comfort and fit.

### Additional Features:

- Tricot fabric for extra comfort and shock absorption.
- Foam covered plastic abdominal pad gives added protection in lower abdominal area.
- Articulated waist panels bend naturally as player crouches
- Infinitely adjustable velcro waist band accommodates all waist sizes.
- Leg cinch permits cup to be drawn tight against pelvic area for greater comfort and protection.
- available in black only.



## KLAVA KOLLAR

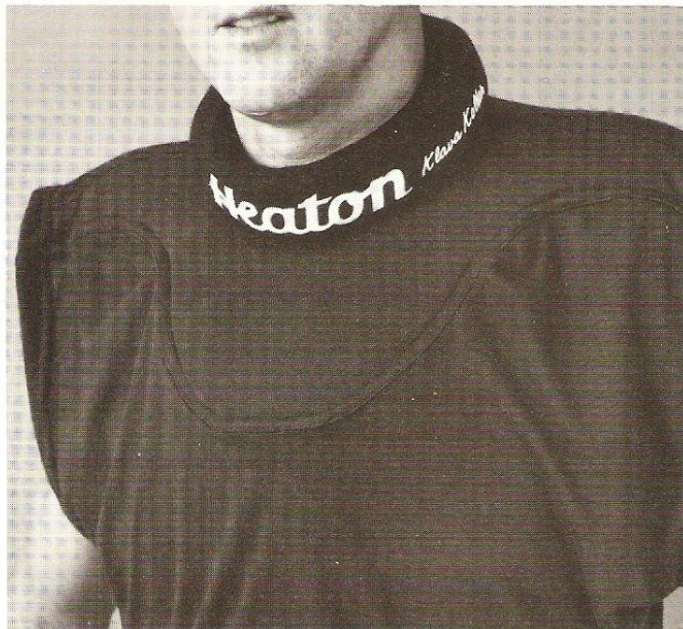

Responding to a demand for more protection of the clavical and upper sternum areas, Heaton offers the Klava Kollar protective collar. As an added measure against skate cuts we have incorporated KEVLAR material into the throat guard portion of this product.

### Additional Features

- High density foam protection in shoulder grid and throat guard for added strength.
- INTERA fabric used in shirt portion offers 13% better sweat absorption than cotton, yet has the stability of polyester.
- Available in black only - S, M, L, XL sizing.

## THROAT COLLARS



This product is available in two sizes: Adult and Youth. Constructed of high density foam and polyethylene plastic it provides cushioned protection for the collar-bone. The covering is of waterproof nylon and is available in colours of white, black, red, and blue.

## PROTECTIVE EQUIPMENT BAG



Heaton has set out to design and build the highest quality hockey bag on the the market. Manufactured in our factory, this heavy duty, multi-compartment bag is high on function and graphic appeal. At 42" x 24" x 24" it is designed to hold all of your equipment except the pads.

### Additional Features:

- Seven compartment design allows player to organize and isolate his various gear.
- End to end detachable strap with generous shoulder pad make for comfortable easy handling and door way passage - short grab handles make quick moves easy.
- Heavy duty brass zipper is used for long life and ease of operation.
- 420 DENIER vinyl backed nylon is heavy duty, long wearing and non-absorbent.
- Special compartment liner to prevent cuts from skate blades.
- Clarino bound corners with breathers for wear resistance and air circulation.
- Available in black/black, black/blue, black/red or black/green colour combinations.

## THIGH PADS

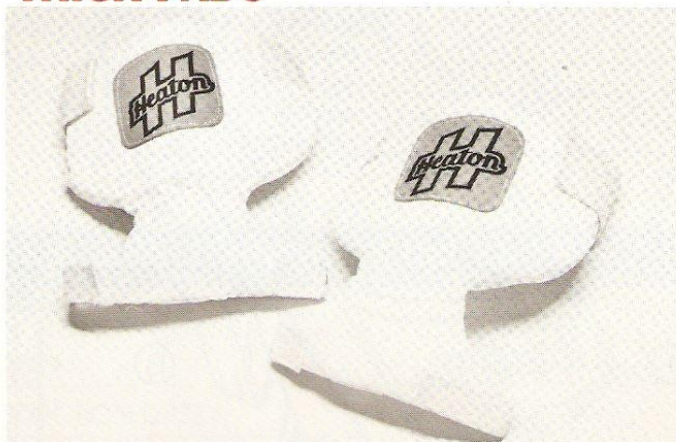

The goalie thigh pad is designed to protect the lower thigh area and is constructed of high density foam and plastic, covered in water resistant nylon. Adult and Youth sizes in White only.

**CATCH GLOVE / COLOR CHART**

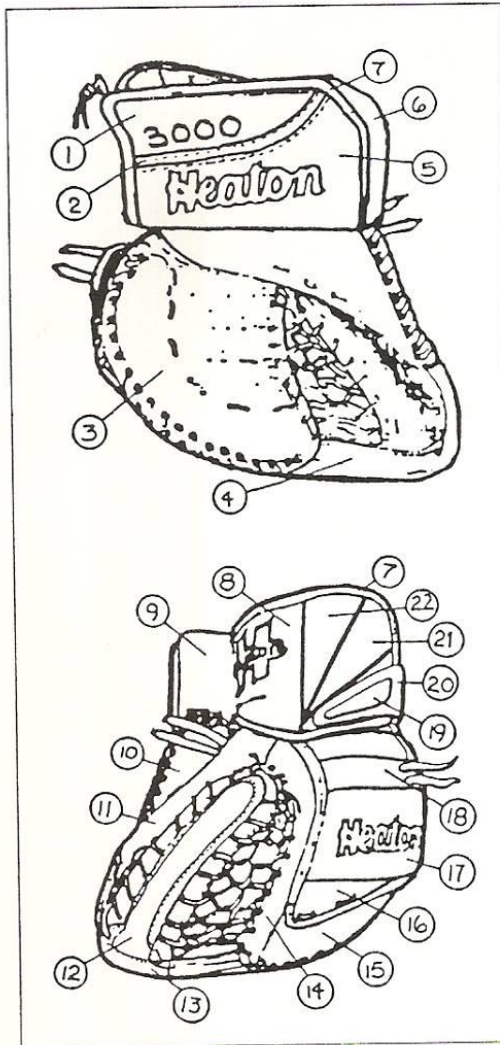

- 1 Blocking Surface \_\_\_\_\_
- 2 Slash \_\_\_\_\_
- 3 Catch Surface \_\_\_\_\_
- 4 Tee Top \_\_\_\_\_
- 5 Logo Patch \_\_\_\_\_
- 6 Gusset \_\_\_\_\_
- 7 Binding \_\_\_\_\_
- 8 Logo Backing \_\_\_\_\_
- 9 Inside Cuff \_\_\_\_\_
- 10 Outer Thumb \_\_\_\_\_
- 11 Outer Yoke \_\_\_\_\_
- 12 Rocket \_\_\_\_\_
- 13 Outer Tee \_\_\_\_\_
- 14 Inner Yoke \_\_\_\_\_
- 15 Finger Tip \_\_\_\_\_
- 16 Extention \_\_\_\_\_
- 17 Finger Pad \_\_\_\_\_
- 18 Knuckle Rolls \_\_\_\_\_
- 19 Foam Tab \_\_\_\_\_
- 20 Tab \_\_\_\_\_
- 21 Cuff One \_\_\_\_\_
- 22 Cuff Two \_\_\_\_\_
- 23 Knuckle One \_\_\_\_\_
- 24 Knuckle Two \_\_\_\_\_
- 25 Knuckle Three \_\_\_\_\_
- 26 Knuckle Four \_\_\_\_\_
- 27 Cuff A \_\_\_\_\_
- 28 Cuff B \_\_\_\_\_
- 29 Lace color (one only) \_\_\_\_\_

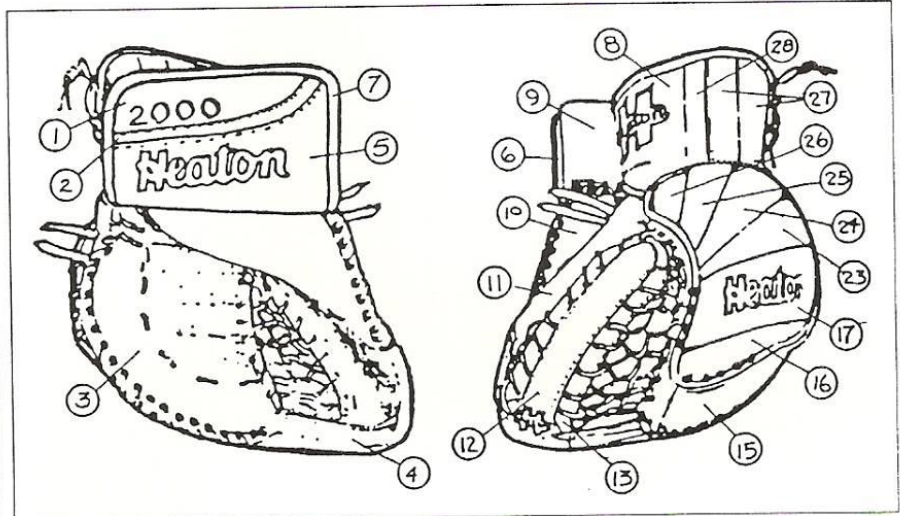

**BLOCKER / COLOR CHART**

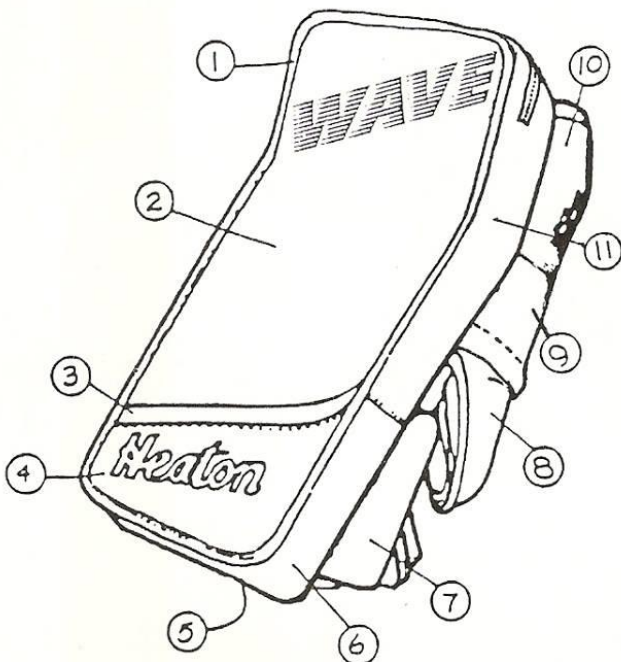

- 1 Binding \_\_\_\_\_
- 2 Face \_\_\_\_\_
- 3 Slash \_\_\_\_\_
- 4 Logo Patch \_\_\_\_\_
- 5 Under Side \_\_\_\_\_
- 6 Toe Gusset \_\_\_\_\_
- 7 Finger Protectors \_\_\_\_\_
- 8 Thumb \_\_\_\_\_
- 9 Wrist Roll \_\_\_\_\_
- 10 Cuff \_\_\_\_\_
- 11 Side Gusset \_\_\_\_\_
- 12 Lace colour (one only) \_\_\_\_\_

**INTERNAL USE ONLY**

DEALER :
PROD. #:
PRODUCTION DATE :
CMF TAG :
ITEM :

## GOAL PADS / COLOR CHART

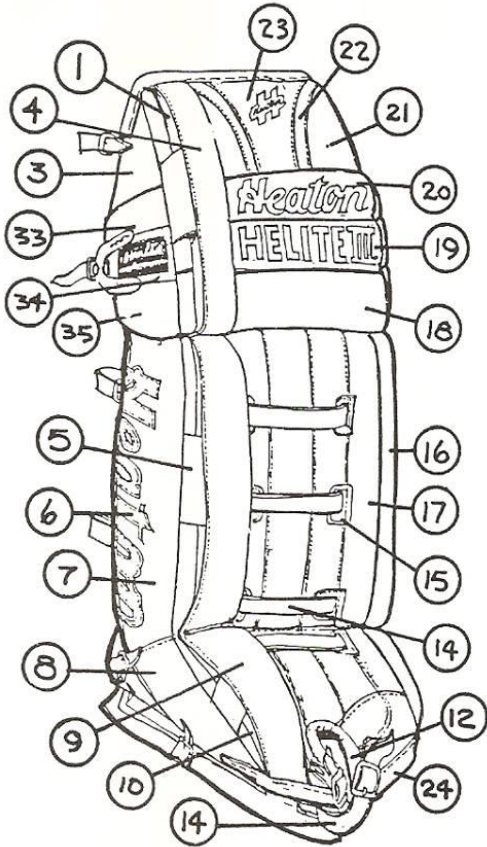

**HELITE III**

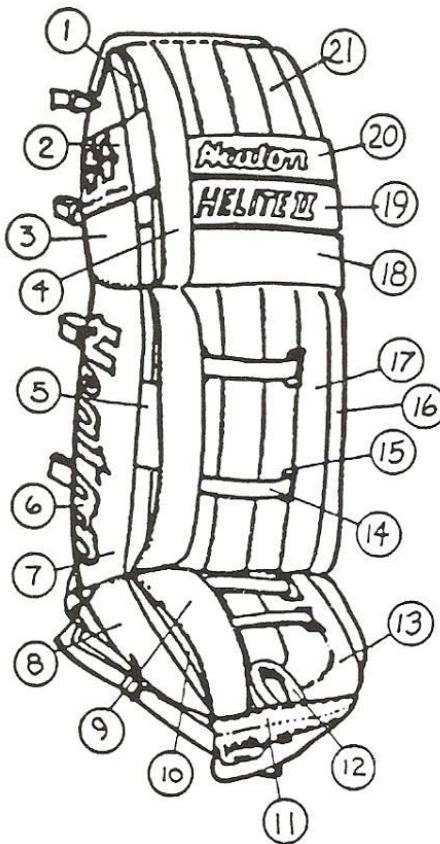

**HELITE II**

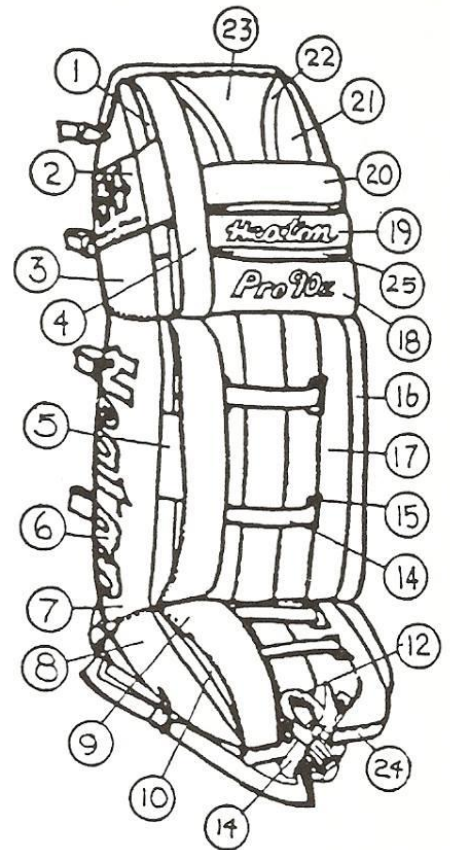

**PRO 90Z**

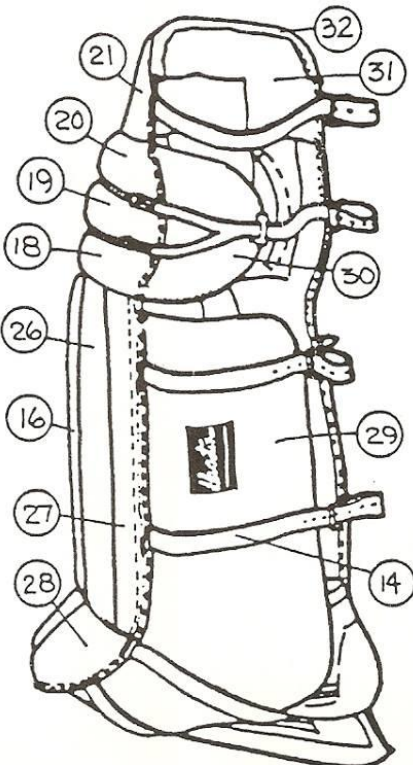

- |                          |                           |
|--------------------------|---------------------------|
| 1 Roll Back _____        | 19 Middle Knee Roll _____ |
| 2 Logo Foundation _____  | 20 Upper Knee Roll _____  |
| 3 Upper Gusset _____     | 21 Thigh Rise _____       |
| 4 Upper Roll _____       | 22 Thigh Slash _____      |
| 5 Tie Down _____         | 23 Thigh Patch _____      |
| 6 Logo _____             | 24 Toe Caps _____         |
| 7 Gusset _____           | 25 Mini Rolls _____       |
| 8 Boot Gusset _____      | 26 Inside Gusset _____    |
| 9 Lower Roll _____       | 27 Sixth Roll _____       |
| 10 Roll Back _____       | 28 Inside Boot _____      |
| 11 Puckfall _____        | 29 Wing Wrap _____        |
| 12 Toe Binding _____     | 30 Knee Flare _____       |
| 13 Boot Face _____       | 31 Inside Thigh _____     |
| 14 Straps _____          | 32 Top Binding _____      |
| 15 Tabs _____            | 33 1st wrap _____         |
| 16 Medial Roll _____     | 34 2nd wrap _____         |
| 17 Shin Face _____       | 35 3rd wrap _____         |
| 18 Lower Knee Roll _____ |                           |

**INTERNAL USE ONLY**

DEALER :
PROD. #:
PRODUCTION DATE :
CMF TAG :
ITEM :

**Heaton**

**SALES OFFICES:**

---

**ONTARIO / OVERSEAS**

Dennis M. Smith  
Vice President - Marketing  
Head Office:  
357 Walker Rd.  
Harrow, Ontario N0R 1G0  
Telephone: (519) 738-3591  
Fax: (519) 738-3595

**ATLANTIC CANADA**

Hollington Agencies  
(Kevin Doucette)  
34 Driscoll Crescent  
Moncton, N.B. E1E 3R8  
Telephone: (506) 857-4897  
Fax: (506) 857-4899

**UNITED STATES**

Randy Wilson  
1338 Penarth  
Commerce, Michigan 48382  
Telephone: (313) 363-5830  
Fax: (313) 363-6754

**EASTERN ONTARIO / QUEBEC**

Pro Sports Marketing  
(Todd Murray and Claude Percival)  
274 Dorval Ave.  
Dorval, PQ H9P 3H3  
Telephone: (514) 631-1150  
Fax: (514) 631-8109

**LAKEHEAD / WESTERN CANADA**

David Reid Agencies  
380 McGee St., Second Floor  
Winnipeg, Manitoba R3G 1M9  
Telephone: (204) 772-0349  
Fax: (204) 783-0987